



152 Robbins Rd, Downingtown, PA, 19335, USA - HuddleCamHD.com | 1 800 - 486-5276

HuddleCamHD 10x

USB 3.0 PTZ CAMERA

INSTALLATION & OPERATION MANUAL





152 Robbins Rd, Downingtown, PA, 19335, USA - HuddleCamHD.com | 1 800 - 486-5276

Precautions.....

Safety Tips.....

- Please read this manual carefully before using the camera.
- Avoid damage from stress, violent vibration or liquid intrusion during transportation, storage or installation.
- Take care of the camera during installation to prevent damage to the camera case, ports, lens or PTZ mechanism.
- Do not apply excessive voltage. (Use only the specified voltage.) Otherwise, you may experience electrical shock.
- Keep the camera away from strong electromagnetic sources.
- Do not aim the camera at bright light sources (e.g. bright lights, the sun, etc.) for extended periods of time.
- Do not clean the camera with any active chemicals or corrosive detergents.
- Do not disassemble the camera or any of the camera's components. If problems arise, please contact your authorized dealer.
- After long term operation, moving components can wear down. Contact your authorized dealer for repair.

Supplied Accessories.....

- 10x Zoom USB 3.0 HD Video Conference Camera (1)
- 12V/2.0A DC Power Adapter (1)
- Tripod Mounting System (1)
- USB 3.0 Data Cable (3m), Serial Control Cable, RS-232C to RS-485 Adaptor
- IR Remote Controller
- User Manual (1)

Physical Description.....

1. Front View.....



1. **Lens**
2. **IR Receiver**
To receive IR remote controller signal.
3. **Power LED**
Blue LED lights when unit is powered, LED is dark for Stand-By status.
4. **IR Receiver**
To receive IR remote controller signal.

2. Rear View.....

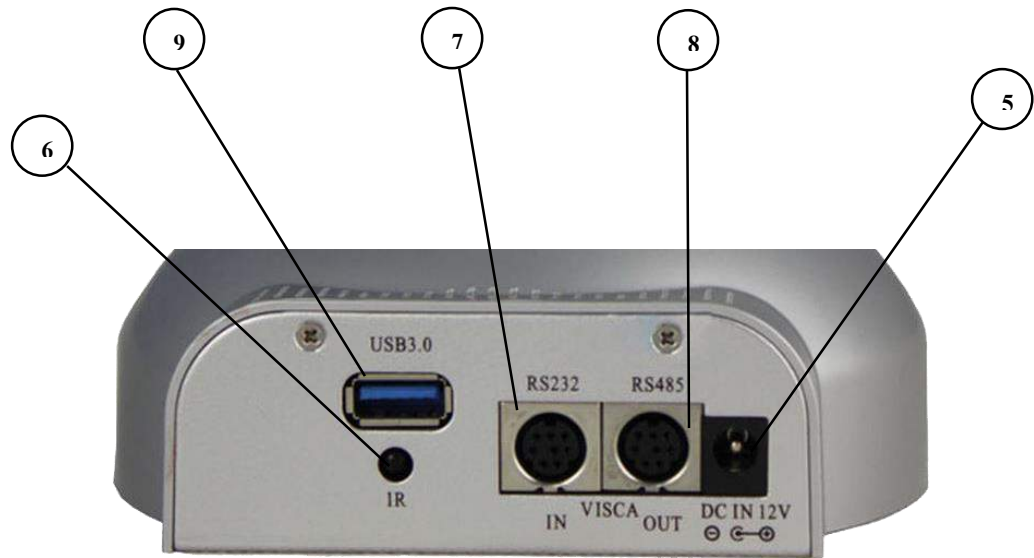

5. DC IN 12V Socket

Only use the Power Adapter supplied with this camera.

6. IR Receiver

To receive IR remote controller signals.

7. VISCA IN Port

For hard wired remote control from a 3rd party PC, joystick, etc...

8. VISCA Out Port/RS485

Used for daisy chaining multiple cameras for RS-232 RS-485 control.

9. USB 3.0 Interface

For connection to PC (USB 3.0 port. Will also function in a USB 3.0 port as USB 2.0 device).

3. Bottom View.....

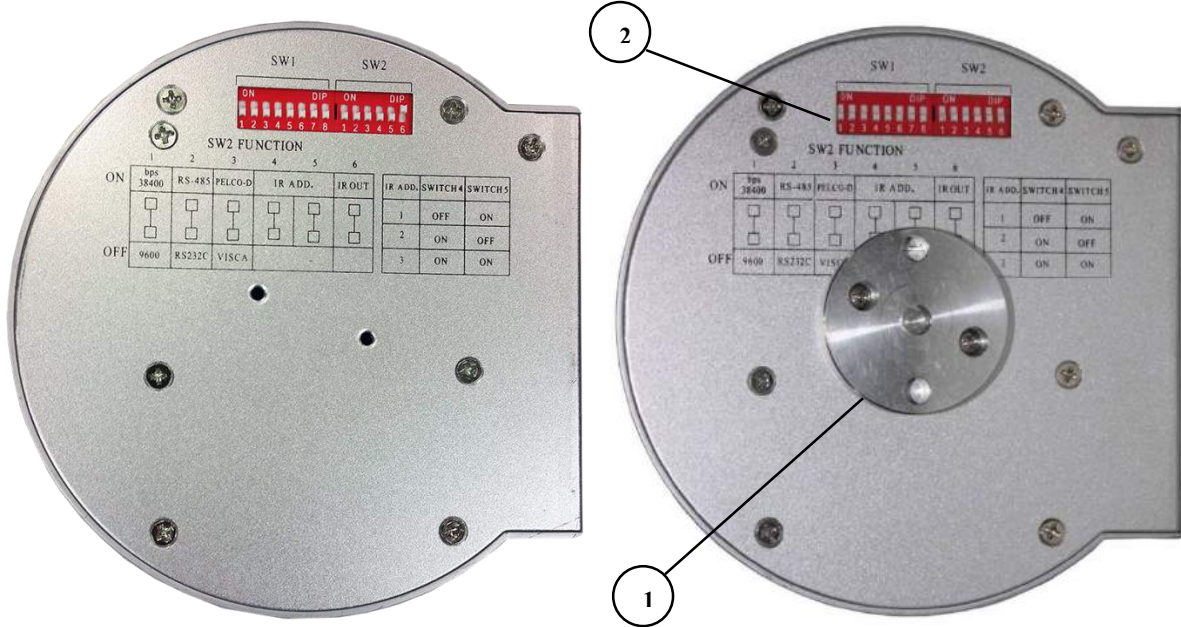

1. Tripod

Will accept 1/4-20 bolt from 3rd party tripod, wall or ceiling mount using included tripod adapter.

2. Dip-Switch

Used for selecting serial and IR communications settings.

4. Dip-Switch Settings.....

Note: When changing Dip-Switch settings, make all changes with camera powered off.

SW1: Used for setting RS232 address.

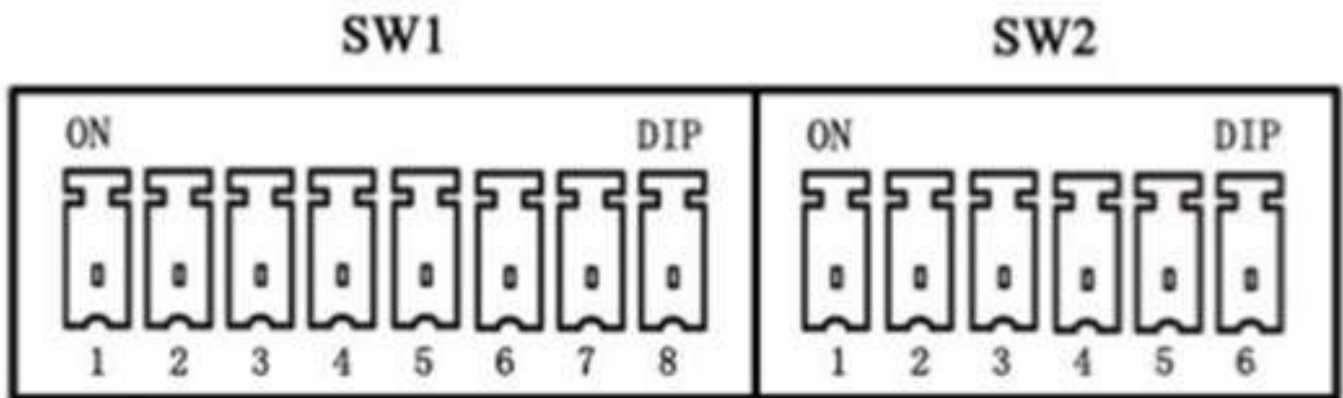

Address	SW1 Switch State 1-7, (8 for stand-by)						
	DIP-1	DIP-2	DIP-3	DIP-4	DIP-5	DIP-6	DIP-7
1	ON	OFF	OFF	OFF	OFF	OFF	OFF
2	OFF	ON	OFF	OFF	OFF	OFF	OFF
3	OFF	OFF	ON	OFF	OFF	OFF	OFF
4	OFF	OFF	OFF	ON	OFF	OFF	OFF
5	OFF	OFF	OFF	OFF	ON	OFF	OFF
6	OFF	OFF	OFF	OFF	OFF	ON	OFF
7	OFF	OFF	OFF	OFF	OFF	OFF	ON

Notes:

1. Broadcast address: If the Joystick is 255 (all dip switches on), any Camera can be controlled by any address.
2. Test Address: If the dome camera address is 0 (all dip switches off), any address code can control the dome camera.



HuddleCamHD

152 Robbins Rd, Downingtown, PA, 19335, USA - HuddleCamHD.com | 1 800 - 486-5276

SW2: Used for communication settings.

SW2 DIP-1,2,3: Baud Rate, Communication Protocol

Baud Rate	SW2 DIP-1	Communication Mode	SW2 DIP-2	Communication Protocol	SW2 DIP-3
9600bps	OFF (Def)	RS-232	OFF (Def)	VISCA	OFF (Def)
38400bps	ON	RS-485	ON	PELCO-D	ON

SW2 DIP-4,5: IR Remote Control Receiving Address Table

IR Remote Address	SW2 Switch State (4-5)	
	DIP-4	DIP-5
0	OFF (Def)	OFF (Def)
1	OFF	ON
2	ON	OFF
3	ON	ON

SW2 DIP-6: IR Output

IR Out	SW2 DIP-6
Disabled	OFF (Def)
Enabled	ON

[Cable Connection Info.....](#)

[VISCA RS-232C - IN Reference.....](#)

VISCA RS-232C IN

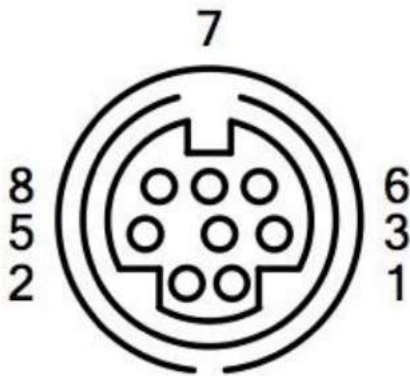

Pin S/N	Function
1	DTR IN
2	DSR IN
3	TXD IN
4	GND
5	RXD IN
6	GND
7	IR Commander Signal OUTPUT
8	NO Connection

[VISCA RS-232C - Out Reference.....](#)

VISCA RS-232C OUT

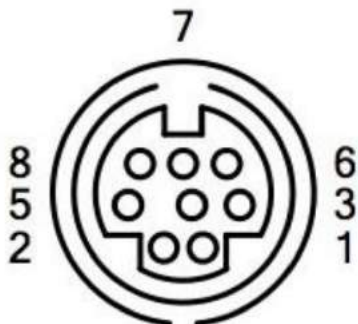

Pin S/N	Function	
	RS-232	RS-485
1	DTR OUT	TX+
2	DSR OUT	TX-
3	TXD OUT	
4	GND	
5	RXD OUT	
6	GND	
7		RS-485 -
8		RS-485 +



152 Robbins Rd, Downingtown, PA, 19335, USA - HuddleCamHD.com | 1 800 - 486-5276

OSD MENU.....

On Screen Display Menu - Use the OSD menu to access and change the camera's settings.

Note: You cannot manually move the camera (pan/tilt) when the OSD menu is visible on the screen.

The Dome OSD Menu is as follows:

- **Pan Speed** **Default Value: 20**
Set speed of Pan motor - Range
 - 1 - 63
- **Tilt Speed** **Default Value: 20**
Set speed of Pan motor - Range
 - 1 - 63
- **Scan Speed (Auto Pan Mode)** **Default Value: 6**
Set speed of boundary scan - Range
 - 1 - 63
- **Tour Path (uses presets)** **Default Value: 1**
Select desired tour path - Range
 - 1 - 4
- **Tour Dwell** **Default Value: 5**
Set duration to dwell on each preset - Range
 - 1 - 60
- **Proportion** **Default Value: On**
Set Proportion - Range
 - On - Off
- **Auto Rev** **Default Value: P**
Set camera mounting orientation
 - N for inverted ceiling mount
- **Frame** **Default Value: 60Hz**
Set Refresh Rate - Range
 - 50Hz or 60 Hz



152 Robbins Rd, Downingtown, PA, 19335, USA - HuddleCamHD.com | 1 800 - 486-5276

The Lens OSD Menu is as follows:

- **DISPLAY** Default Value: Off
On Screen Display
 - On or Off

- **SHARPNESS** Default Value: Low
Level of Sharpness:
 - Low/Normal/High

- **SATURATION** Default Value: Normal
Level of Saturation
 - Low/Normal/High

- **NR (Noise Reduction)** Default Value: 3
Adjustable Value
 - 0-5

- **WB (White Balance)** Default Value: Auto
Auto/Manual/Outdoor/Indoor/One Push/ATW
(Manual Settings):
 - **R GAIN (Red Gain)** Default Value: 206
Adjustable Scope: 0-255
 - **B GAIN (Blue Gain)** Default Value: 150
Adjustable Scope: 0-255

- **AE (Auto Exposure)** Default Value: Auto
Auto/Manual
(Manual Settings):
 - **SHUTTER** Default Value: 1/1
Shutter Speed Range: 1/1-1/10000
 - **IRIS** Default Value: Close
Close/F1.4-f22
 - **BRIGHT** Default Value: 0
 - Set Brightness 0 - 31



IR Remote Controller (Note: Some buttons do not operate for all camera models)

1. **Reset:**
Restarts the camera and restores it to Factory Default settings.
(Note: Will delete all memory).
2. **Camera Selection**
Select Camera ID: 1, 2 or 3
3. **Preset Positions**
1-9: Preset Positions
Set: Setting Preset Position
Clear: Clear Preset Position
Call: Call Preset Position
Note: If you want to set (or call) the first preset position to 1, you should press number key "1", then press "Set" (or "Call") to set (call) the position.
4. **Fast Zoom in/out Control Zone**
+: Zoom in quickly
-: Zoom out quickly
5. **Pan/Tilt Controller**
 - Move Up
 - Move Down
 - Move Left
 - Move Right
 - Auto Pan
6. **Additional Function Zone**
Freeze: Image Freeze
BL: Back-light Compensation
WB: White Balance
AE: Auto Exposure
D Zoom: Digital Zoom
HDMI: Swap to HDMI video output
DVI: Swap to DVI video output
Format: Swap between different formats
7. **Power Supply Switch**
Switch for turning camera on (i.e. Stand-By mode vs. Working mode)
8. **OSD Menu Zone**
Dome OSD: Enter Pan Tilt Zoom OSD menu
Lens OSD: Enter lens OSD menu
9. **Slow Zoom In/Out Zone**
+: Zoom in slowly
-: Zoom out slowly
10. **Focus Control Zone**
Auto: Turn on auto focus
Manual: Turn on manual focus
Far: Set focus at farther distance
Near: Set focus at nearer distance

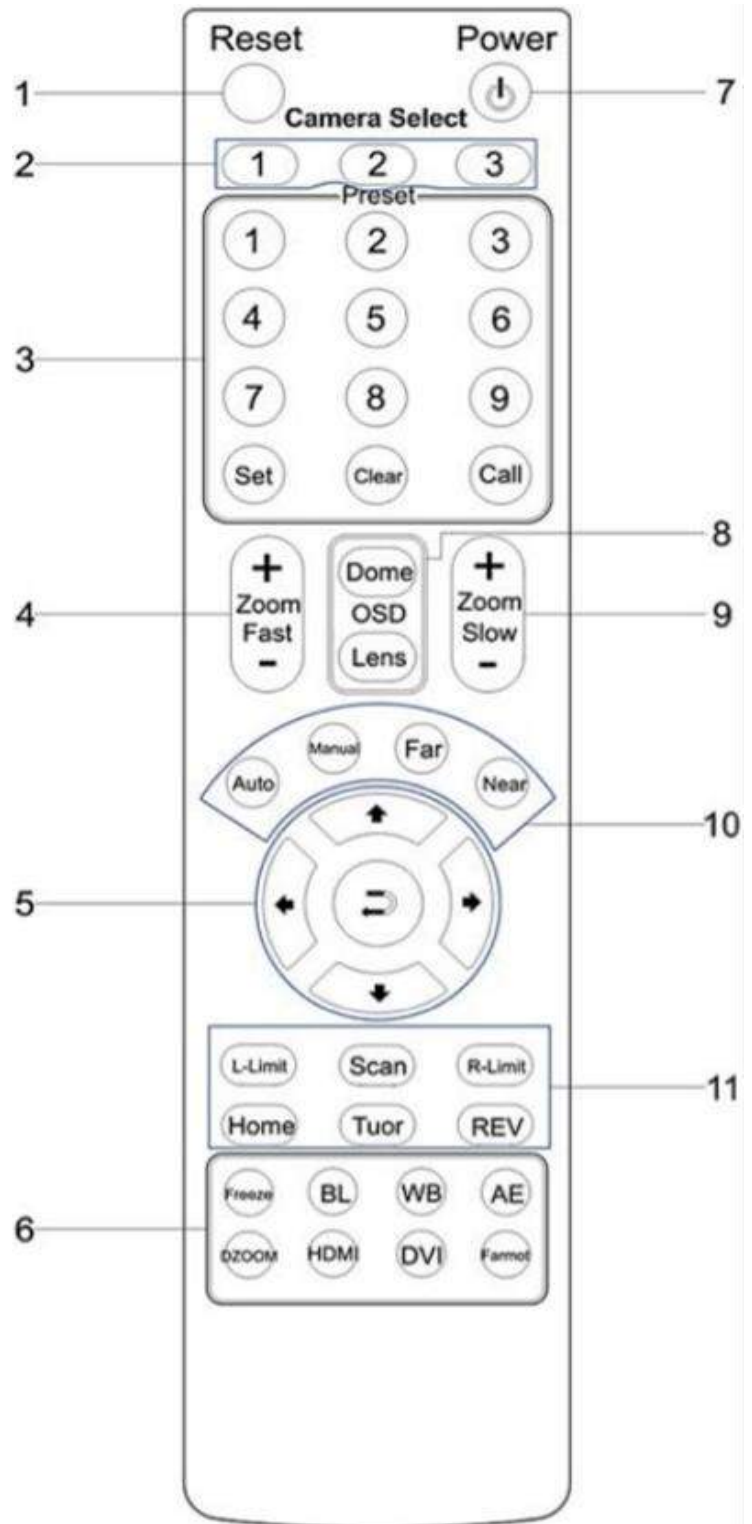



152 Robbins Rd, Downingtown, PA, 19335, USA - HuddleCamHD.com | 1 800 - 486-5276

- 11. **Pan/Tilt Function Zone**
 - L-Limit: Set left boundary limit scanning position
 - Scan: Enable Boundary Scanning (Auto Panning)
 - R-Limit: Set right boundary limit scanning position
 - Home: Go to camera's Home position
 - Tour: Enable automatic patrol tour of presets
 - Rev: Enable image flip for ceiling mounting

Connection Instructions.....

1. Connect included Power Supply to the camera.
2. Wait for camera to come to Home Position.
3. Connect included USB 3.0 cable to camera and USB 3.0 port of PC.
4. Select and configure camera in your software of choice.

NOTE: Failure to follow this sequence may result in no connection to PC.

Care Of The Unit.....

Remove dust or dirt on the surface of the lens with a blower (commercially available).



152 Robbins Rd, Downingtown, PA, 19335, USA - HuddleCamHD.com | 1 800 - 486-5276

Installation Instructions.....

Desktop Installation.....

When using the HuddleCam™ on a desk, Make sure that it will stand level. If you want to use the camera on an incline, make sure the angle is less than 15 degrees to ensure that the camera's pan and tilt mechanism operates normally.

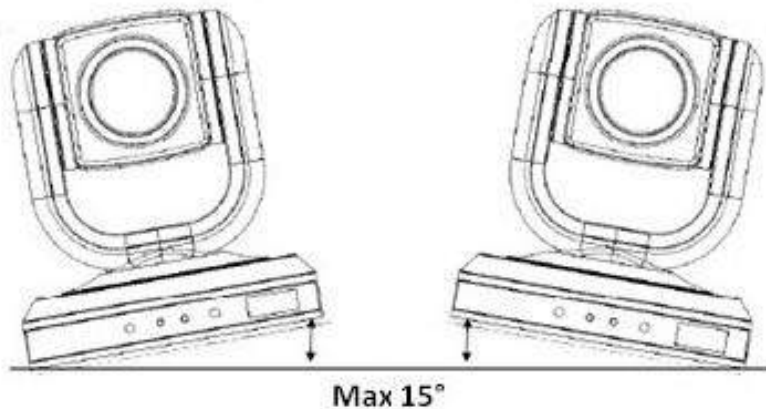

Tripod Installation.....

When using the HuddleCam™ with a tripod, screw the tripod to the bottom of the camera. The tripod screw must fit below specifications:

Note: Tripod must stand on a level surface.



152 Robbins Rd, Downingtown, PA, 19335, USA - HuddleCamHD.com | 1 800 - 486-5276

Troubleshooting.....

Problem	Cause	Resolution
There is no power to the camera.	Power adapter is disconnected from mains or from camera.	Check the connections between the camera, power adapter and mains. If anything is disconnected, reconnect it.
Camera will not connect to the PC via USB.	USB cable is bad.	Try new USB Cable
	Camera connects sometimes.	Connect USB only after camera has completely booted.
Camera unable to pan, tilt, and/or zoom.	Menu is currently displayed on the screen.	Retry after exiting the menu.
	Pan, tilt or zoom range limit was reached.	Try to pan/tilt/zoom in the other direction.
Remote control not working.	The “camera select” button on the remote control is not set to match the “IR address” set on the camera dip switch.	Choose the correct “IR select” number to match camera settings.
Camera cannot be controlled via VISCA.	The connection between the PC and camera is incorrect.	Refer to Cable Connection Info section of this manual.
	Commands being sent are incorrect.	Refer to VISCA manual.
The Camera is not working at all.	No response or image from camera.	Disconnect power, and wait a few minutes, then connect the power again. Retry.



152 Robbins Rd, Downingtown, PA, 19335, USA - HuddleCamHD.com | 1 800 - 486-5276

Important Notes Regarding USB Connectivity:

USB 3.0 ports are backwards compatible with USB 2.0 devices. USB 2.0 ports are not completely forward compatible with USB 3.0 devices (some USB 3.0 devices will connect to USB 2.0 with limited functionality).

External USB hubs should be avoided (i.e. give the camera its own USB port on the device) as they are not well suited to transmitting HD video reliably.

USB extension systems must be fully compatible with the version of USB that you are using and must utilize an external power supply, when required. Caution: Some “compatible” USB 3.0 extenders do not actually have the full 5Gbps bandwidth required for uncompressed HD video - so check bandwidth specs. Always connect the HuddleCam directly to the device in order to associate the UVC drivers before attempting to use any extension system.

USB 3.0 power saving settings in the device’s operating system should be turned off completely for reliable USB 3.0 camera connectivity.

HuddleCam Cameras

All HuddleCamHD cameras utilize the UVC (USB Video Class) drivers that are built into Windows, Mac OS and Linux to stream HD video to your device via your device’s USB port (*USB 2.0 or USB 3.0 depending upon HuddleCam model*). When your device successfully recognizes the camera, your device will register the HuddleCam as an “imaging device”. You can see this in your Windows Device Manager program (type “device manager” into the Windows search tool) as shown in the screenshot, below:



152 Robbins Rd, Downingtown, PA, 19335, USA - HuddleCamHD.com | 1 800 - 486-5276

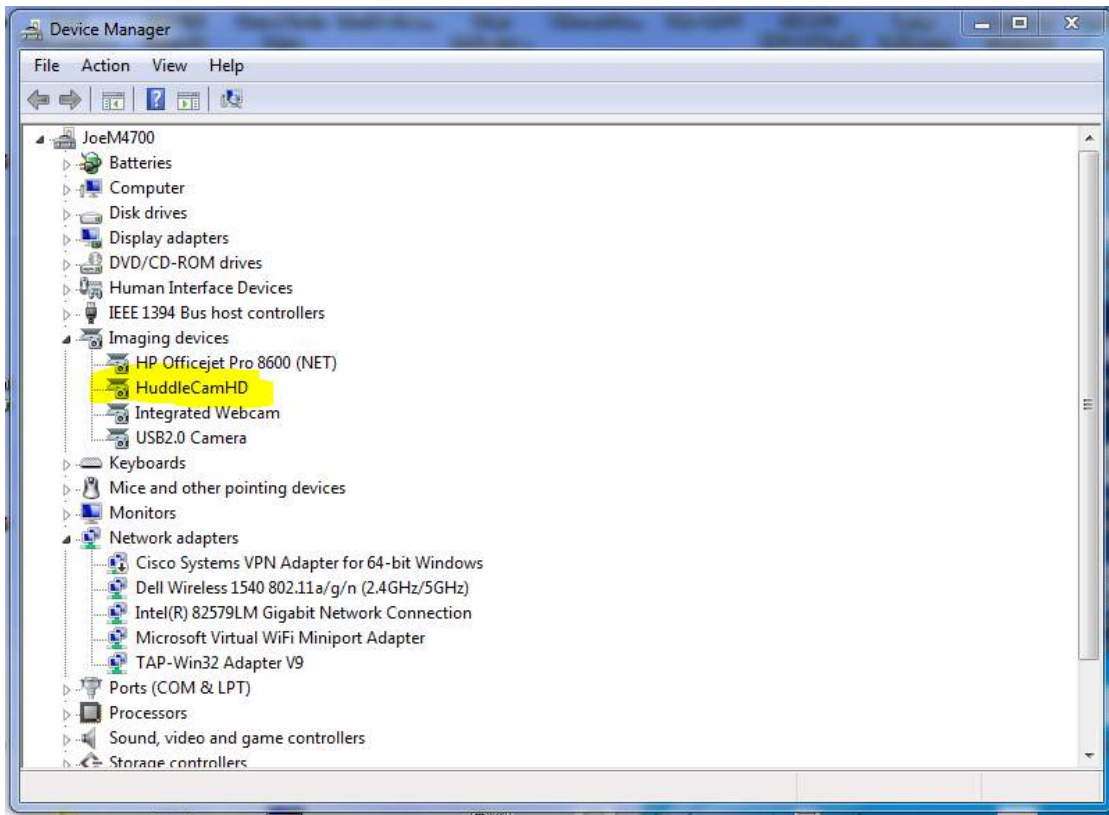

In this example, you can see the HuddleCam model in use connected as a fully functional USB 3.0 device (HuddleCamHD) as well as a USB 2.0 device with limited functionality (USB2.0 Camera).

If your device has not connected to or has not recognized the HuddleCam as an imaging device (in which case, you may see a new “unknown device”, “Westbridge” or “CYTFX3” labeled device show up in Device Manager’s “Universal Serial Bus Controllers” section rather than in the “Imaging Devices” section), the HuddleCam will not be available to programs that utilize a camera. In this case, try restarting the device and reconnecting the camera via USB (*USB 2.0 or USB 3.0 depending upon HuddleCam model*).



152 Robbins Rd, Downingtown, PA, 19335, USA - HuddleCamHD.com | 1 800 - 486-5276

Similarly, you can see a connected device in System Information on a MAC. See screenshot below:



In this example, you can see the HuddleCam model in use connected as a fully functional USB 3.0 device “HuddleCamHD” as well as a “USB2.0 camera” with limited functionality (USB2.0 camera).



152 Robbins Rd, Downingtown, PA, 19335, USA - HuddleCamHD.com | 1 800 - 486-5276

Specs.....

Model Number: HC10X-(xx)-G2

Color (xx): WH=White; BK=Black; SV=Silver

Camera & Lens

- Video CMOS Sensor 1/3" CMOS, 2.1 Mega Pixel
- Frame Rate 30fps 1920 x 1080p
- Lens Zoom 10X Optical Zoom f=5 -50mm F2.0-2.8
- Field of View 7° (tele) to 51° (wide)
- Warranty 2 Years

Pan/Tilt Movement

- Pan Movement ±359°
- Tilt Rotation Up: 90°, Down: 45°
- Presets 64 Presets

Rear Board Connectors

- High Definition Interface USB 3.0 micro-B
- Controller Signal Interface Mini DIN-8 (VISCA IN, VISCA OUT/RS485)
- Controller Signal Config. Dip-Switch Pin 7/TTL Signal
- Baud Rate 9600 bds
- Power Supply Interface DC 12V 2A

Electrical Index

- Power Supply Adapter 12V DC 2A
- Input Voltage 12V DC (10.5-14V DC)
- Input Power 24W (Max)
- Working Environment Indoor

Physical

- Material Aluminum, Plastic
- Dimensions 4.88"W x 5.5"H x 4.75"D [6"H w/ Tilt Up]
(124mm x 139mm x 120mm [152mmH w/ Tilt Up])
- Weight 1.66 lbs (0.75 kg)
- Box Dimensions 8.75" x 8.88" x 7" (222mm x 225mm x 178mm)
- Boxed Weight 3.66 lbs (1.66 kg)
- Color Black, White, *Silver (*Special Order)
- Operating Temperature 32°F to + 113°F (0°C to +45°C)
- Storage Temperature -14°F to 140°F (-10°C +60°C)
- Working Environment Indoor only