HuddleCamHD

SimplTrack



Auto Tracking Camera

Installation & Operation Manual



Table of Contents

Precautions	
Safety Tips.....	Page 3
What's in the Box.....	Page 3
Physical Descriptions	
Front View of Camera.....	Page 4
Bottom View of Camera.....	Page 5
Ceiling Mount.....	Page 6
Tripod.....	Page 7
Basic Connection Instructions	
Network setup.....	Page 8
SDI Connections.....	Page 8
USB Connection.....	Page 8
Control, Audio and Power Wiring.....	Page 9
Installation Instructions	
Ceiling Mount.....	Page 10
Tripod.....	Page 11
Interface Descriptions	
SimplTrack Software	
Main Interface.....	Page 12
Configure Network.....	Page 13
Configure System.....	Page 14
Configure Local SD Card Recording.....	Page 15
Configure Advanced Parameters.....	Page 16
On Screen Display (OSD)	
Video.....	Page 18
Exposure.....	Page 18
White Balance.....	Page 19
Pan Tilt Zoom.....	Page 19
Systems.....	Page 20
Status.....	Page 20
Restore Defaults.....	Page 20
VISCA Commands	
ACK / Completion.....	Page 21
Error Messages.....	Page 21
Commands.....	Page 22
Inquiry Commands.....	Page 25
Tips & Tricks.....	Page 27
Care of the Unit.....	Page 28
Troubleshooting.....	Page 29



Precautions

Safety Tips

- Please read this manual carefully before using the camera.
- Avoid damage from stress, violent vibration or liquid intrusion during transportation, storage, or installation.
- Take care of the camera during installation to prevent damage to the camera case, ports, lens, or PTZ mechanism.
- Do not apply excessive voltage, use only the specified voltage. Otherwise, you may experience an electrical shock.
- Keep the camera away from strong electromagnetic sources.
- Do not aim the camera at bright light sources (e.g. bright lights, the sun, etc.) for extended periods of time.
- Do not clean the camera with any active chemicals or corrosive detergents.
- Do not disassemble the camera or any of the camera's components. If problems arise, please contact your authorized dealer.
- After long term operation, moving components can wear down. Contact your authorized dealer for repair.

What's in the Box

Supplied Hardware

- **Tripod (-TP) Option**
 - HuddleCamHD SimplTrack Camera
 - 64 GB of internal storage
 - Power Supply
 - 25' 3G-SDI Cable
 - 3G-SDI to USB3.0 Frame Grabber
 - Tripod Adapter Column
 - Tripod
- **Ceiling Mount (-CM) Option**
 - HuddleCamHD SimplTrack Camera
 - 64 GB of internal storage
 - Power Supply
 - 25' 3G-SDI Cable
 - 3G-SDI to USB3.0 Frame Grabber
 - Ceiling Adapter Column
 - Ceiling Mount Plate

Physical Descriptions

Front View of Camera



- 1. Tracking Camera Head**
- 2. Tracking Camera Lens**
20X Optical Zoom
Field of View: 2.9° (*Tele*) ~ 59.5° (*Wide*)
- 3. Reference Camera Body**
- 4. Reference Camera Lens**
Fixed 2.4mm Lens
Field of View: 78° (*Horizontal*) / 44° (*Vertical*)

Bottom View of Camera

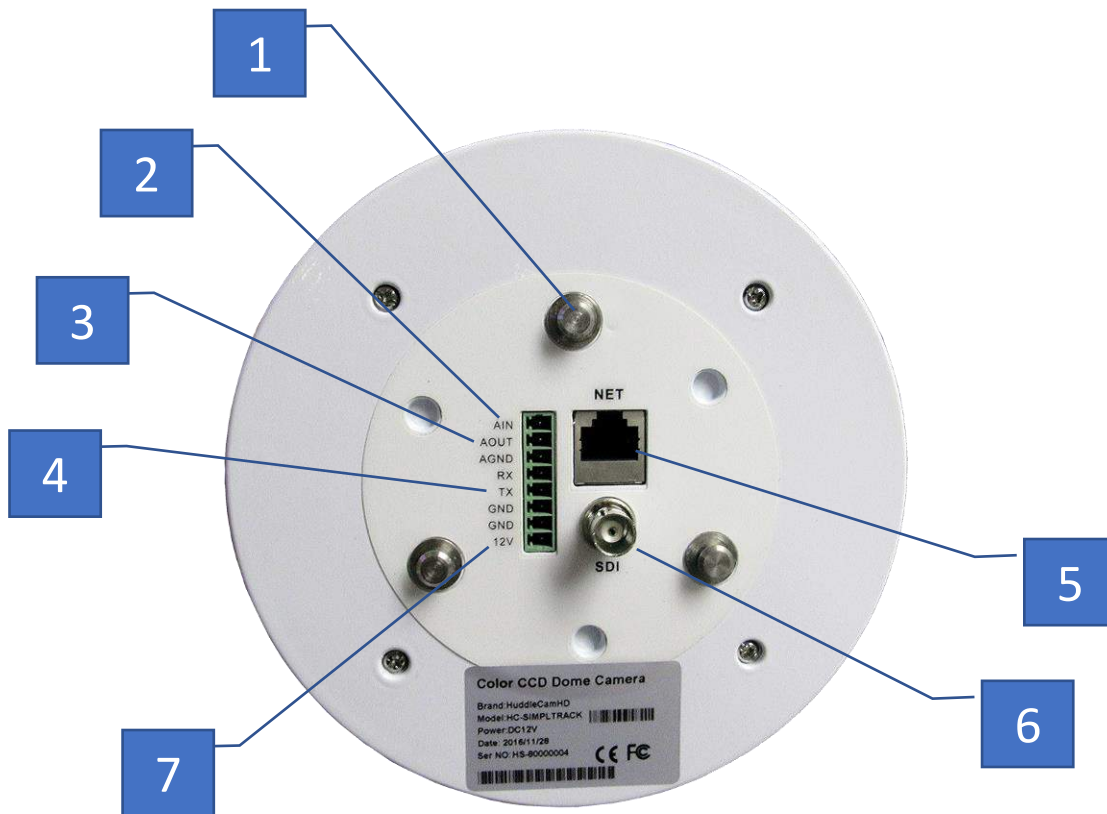

- 1. Locking Studs for connection to Ceiling or Tripod Adapter**
- 2. Audio Input (AIN + AGND)**
Available via RTSP or RTMP
- 3. Audio Output (Future Use)**
- 4. RS-232 (Rx + Tx + GND)**
- 5. Network Interface**
Up to 1080@30 output via RTSP or RTMP
Default setting is for DHCP
- 6. 3G-SDI Output**
Up to 1080@60 output via SDI
- 7. Power (GND + 12V)**

Ceiling Mount



1. Locking Ring Adapter
2. Ceiling Mount Column Adapter
3. Ceiling Mount Plate

Tripod



1. Tripod Column Adapter
2. Tripod



Basic Connection Instructions

To Configure the Camera

1. Connect a live network connection, from a network with a DHCP server, to the camera.
 - a. Note that the camera is set for DHCP by default
2. Connect the included Power Supply to the camera.
3. Wait for camera to come to Home Position.
4. Install the SimplTrack software on your Windows PC on the same network as the camera
5. Open the SimplTrack software to connect to your camera

*Note: To pull the **main RTSP** stream please use the following URL*

rtsp://<camera ip>:<rtsp port>/main.h264

(example: rtsp://192.168.111.85:3750/main.h264)

*Note: To pull the **sub RTSP** stream please use the following URL*

rtsp://<camera ip>:<rtsp port>/sub.h264

(example: rtsp://192.168.111.85:3750/sub.h264)

SDI Connections

1. Connect an SDI cable to the SDI output on the camera.
2. Connect the SDI cable to your equipment with an available SDI input.
 - a. Adjust output resolution via the Software Interface
 - b. Adjust output frame rate via the Software Interface

USB Connections

1. Connect an SDI cable to the SDI output on the camera.
2. Connect the SDI cable to the provided USB3.0 frame grabber
 - a. Adjust output resolution via the Software Interface
 - b. Adjust output frame rate via the Software Interface
3. Connect the USB 3.0 output of the frame grabber to an available USB 3.0 port on your PC

NOTE: Failure to follow these sequences may result in no connection.

Control, Audio and Power Wiring

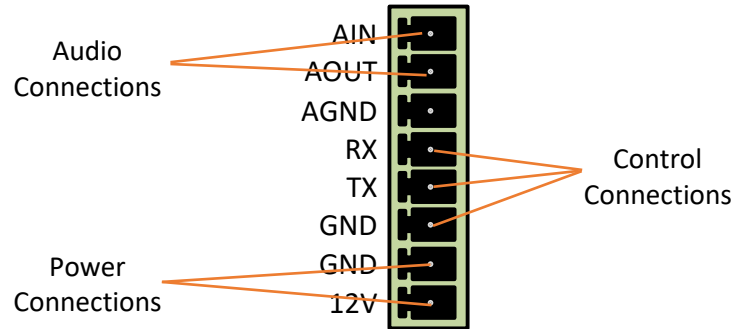

Audio Connections

AIN = Plus
AGND = Ground

Power Connections

GND = 12VDC Ground Connection
12V = 12VDC Positive Connection

Control Connections

RX (cam) = TxD (DB9 ~ Typically Pin 3)
TX (cam) = RxD (DB9 ~ Typically Pin 2)
GND (cam) = Ground (DB9 ~ Typically Pin 5)

NOTE: Failure to follow these sequences may result in no connection.

Installation Instructions

Ceiling Mount



This is the ceiling mount plate with a notch provided for cable access. (please consult your local AHJ for proper installation per your local code)



Route your cable through the notch in the side of the ceiling plate or the opening at the top of the ceiling plate



Route necessary cable through column and then screw the column to the ceiling plate



Route cable through locking adapter ring and screw onto available end of column



Connect all necessary cabling to the appropriate connectors on the cameras base



Use the locking studs on the base of the camera to drop into the available slots on the locking adapter ring and twist to lock into place.

Tripod



This is the provided tripod



Screw the adapter column to the tripod



Route necessary cable through side opening in the column



Connect all necessary cabling to the appropriate connectors on the base of the camera.



Use the locking studs on the base of the camera to drop into the available slots on the adapter column and twist to lock into place.

Interface Descriptions

SimplTrack Software

Main Interface

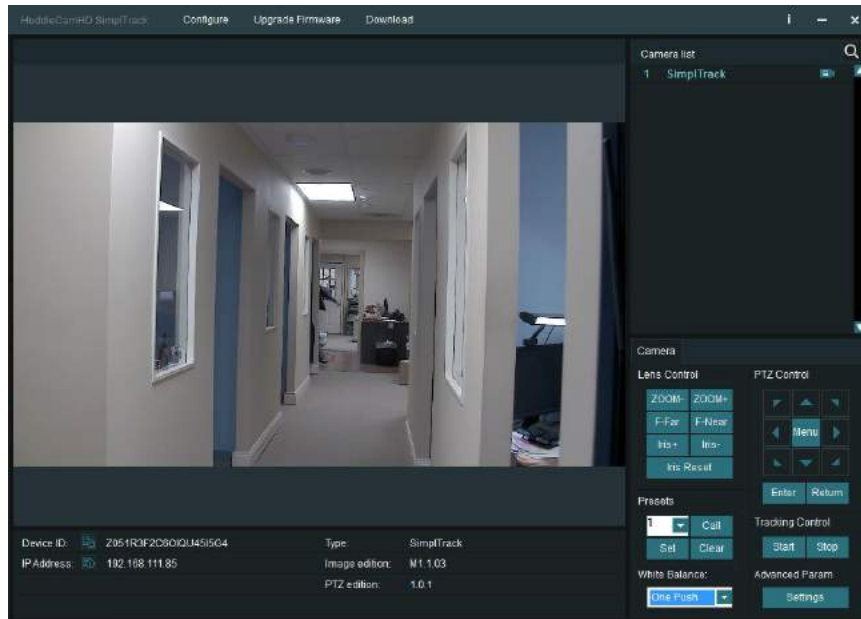

The main interface offers the ability to interact with the basic features of the camera not directly relating to auto-tracking in addition to providing a live preview.

Clicking the magnifying glass in the **Camera List** section will show the available auto tracking cameras on a network. Simply double click on an available camera to connect.

Under **Lens Control**, standard controls are available for **Zoom** (*Tele / Wide*), **Focus** (*Near / Far*), **Iris** (Open / Close), and **Iris Reset**.

The **Presets** section will **Set**, **Call**, and **Clear** Presets 0-255. *Note that **Preset 1** is used as a reference for framing your tracking subject and **Preset 0** is typically used for framing your stage / podium.*

The **White Balance** drop down menu allows **Automatic** or **One-Push** for white balance settings; more options are available via the On-Screen-Display (OSD).

The **PTZ Controls** section serves two functions: first, to provide Pan and Tilt controls when not in an auto-tracking mode, the other is to control the OSD using the **Menu** button.

Tracking Control starts or stops the auto-tracking mode.

Advanced Parameters allows you to setup the auto-tracking mode parameters.

Configure Network

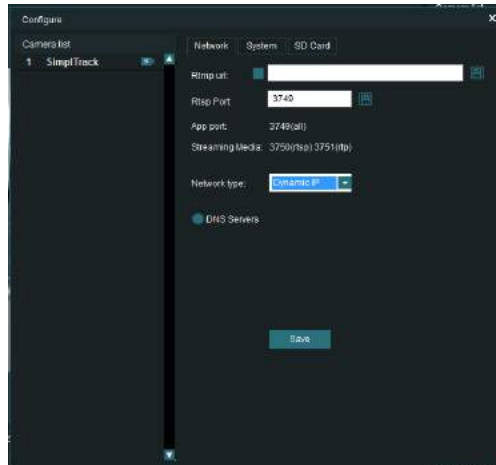

The **Camera List** section will display available auto tracking cameras on your network. Simply double click on an available camera to connect.

For streaming to an RTMP Server, such as YouTube Live, enter the **RTMP URL / Key** into the available textbox and click the save icon.

The **RTSP Port** field will alter the port associated with RTSP streaming; this can be verified by looking at the text shown below the RTSP Port field, showcasing the ports currently used by the camera and software.

The **Network Type** determines if the camera will use **DHCP** (*default*) to connect to a network or allows the assignment of a **Static IP**, in the event DHCP will not work for a network.

Configure System

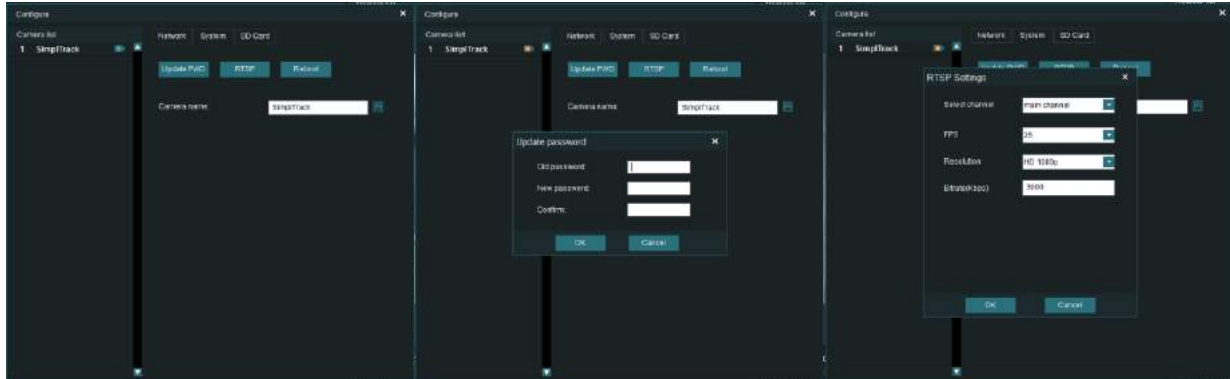

The **System** interface updates the name associated with the camera, password, RTSP output settings, and reboot the camera remotely.

The **Camera name** shows in the Camera List when you are searching for your SimpliTrack on the network.

Update PWD updates the password associated with the web interface of the camera as long as the existing password is available (*Default password is "admin"*).

The **RTSP** section adjusts the frames per second, resolution, and bitrate of the main and sub RTSP feeds.

*Note: To pull the **main RTSP** stream please use the following URL*
rtsp://<camera ip>:<rtsp port>/main.h264
(example: rtsp://192.168.111.85:3750/main.h264)

*Note: To pull the **sub RTSP** stream please use the following URL*
rtsp://<camera ip>:<rtsp port>/sub.h264
(example: rtsp://192.168.111.85:3750/sub.h264)

The **Reboot** button will reboot the camera from the software.

Configure Local SD Card Recording

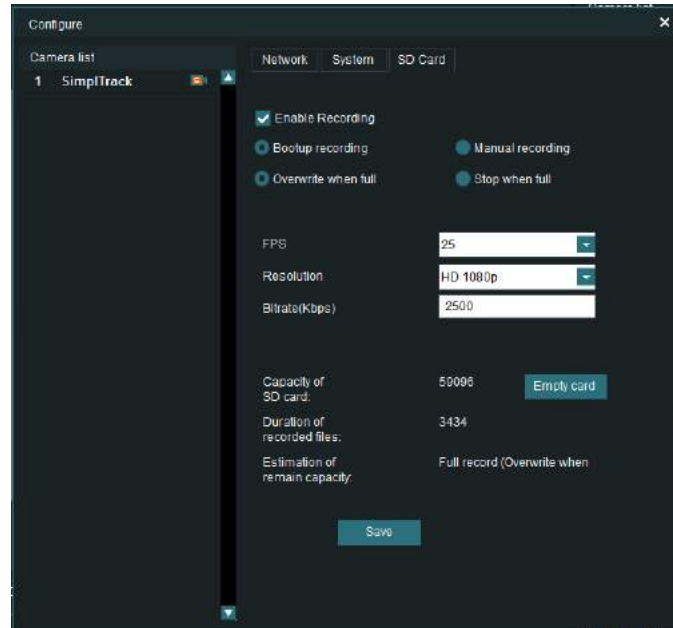

The **SD Card** interface allows the parameters regarding how and when the camera records content to its internal 64GB of storage.

This interface can start or stop the internal recordings by clicking the **Enable Recording** checkbox and clicking Save.

The camera can be set to record once booted up or manually told to record via this interface, additionally setting whether the system will continually overwrite content or stop once full.

The cameras recording settings regarding frame rate, resolution, and bitrate can be set via this interface.

This interface will also allow you to clear all data currently stored on the internal SD Card using the **Empty Card** button.

Configure Advanced Parameters

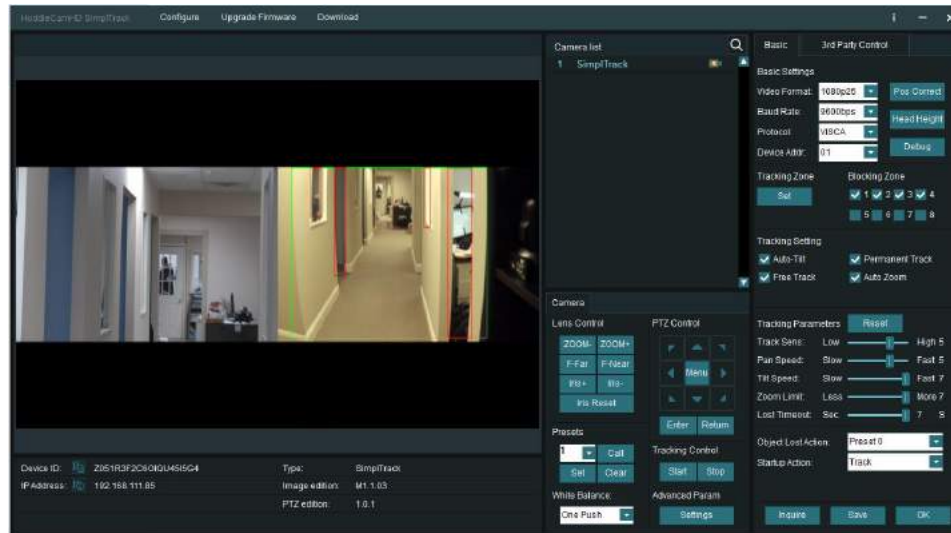

When entering the **Advanced Parameters** settings interface the live preview will switch to a split-screen showing the images from both the reference camera and the tracking camera. This is where all features relating to auto-tracking can be setup.

Under the **Basic Settings** section, the SDI Output resolution and frame rate can be set in addition to protocol settings for the RS-232 connection.

Clicking **Set** in the **Tracking Zone** section will allow you to draw a green rectangle to define a priority tracking area. Within the Tracking Zone you can set **Blocking Zones**, these are areas that the camera will ignore motion within, such as a doorway with people walking by or an LCD screen with active video content displayed. *Note that the Blocking Zones must be used within the Tracking Zone.*

Tracking Setting will define what actions the camera is allowed to perform. **Auto-Tilt** can be used if the subject will be walking towards and away from the camera to maintain the best possible tilt angle as referenced from Preset 1. **Free Track** will allow the camera to follow any moving object even if it is not within the priority tracking zone. **Permanent Track** allows the presenter to venture beyond the defined priority tracking zone and still have auto-tracking capabilities. It is advisable to disable auto-tilt with the last two options to avoid unexpected and extreme tilt angles. **Auto Zoom**, when enabled, will allow the camera to maintain the framing as referenced from Preset 1, and limited by the Zoom Limit, as the subject moves towards or away from the camera.

Configure Advanced Parameters *(Continued)*

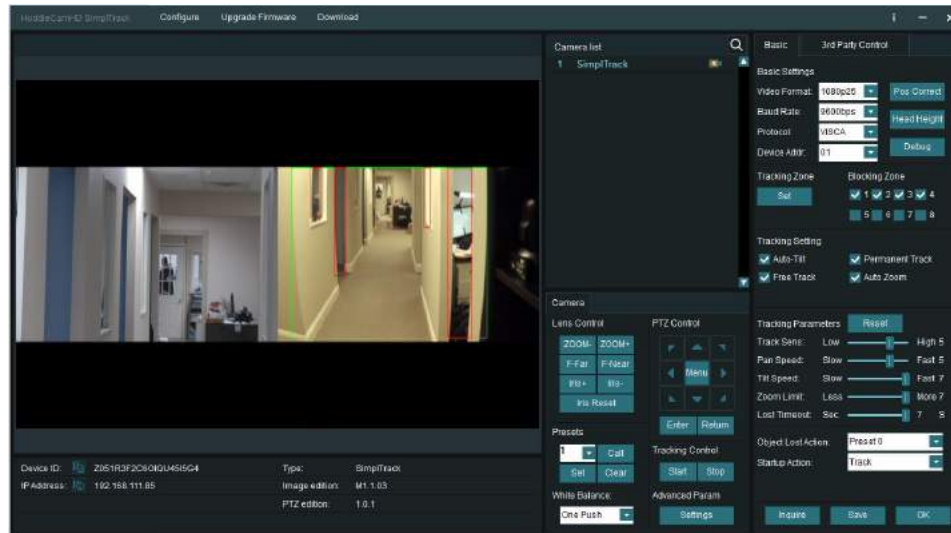

Tracking Parameters will determine how the tracking system should behave in regards to speeds, limits, and what to do when the subject is lost. **Tracking Sensitivity** defines how much motion (**Low** for a little and **High** for a lot) is needed to trigger the auto tracking feature. **Pan Speed** and **Tilt Speed** will control the speed at which the auto tracking is allowed to pan and tilt respectively. **Zoom Limit** allows you to define how much the camera is allowed to intelligently zoom to maintain framing as referenced from Preset 1 when Auto-Zoom is enabled. The **Lost Timeout** allows you to set a time frame for when to respond to the subject being lost ranging from 1 second to 7 seconds.

The **Object Lost Action** tells the camera to go to **Preset 0**, **Preset 1** or to **Stay** when the Lost Timeout has been triggered.

Startup Action allows the camera to default to auto-tracking when turned on or to wait for a user to click the Start button under Tracking Control to turn on the tracking feature.

When all settings are finalized do not forget to click the **Save** button! Clicking **OK** will exit the Advanced Parameters section and return the live preview to the tracking camera feed only.

Note that when working with multiple SimpliTrack systems you can ensure you are working on live settings for each camera by clicking the **Inquire** button to query the connected camera for its current settings.



On Screen Display (OSD)

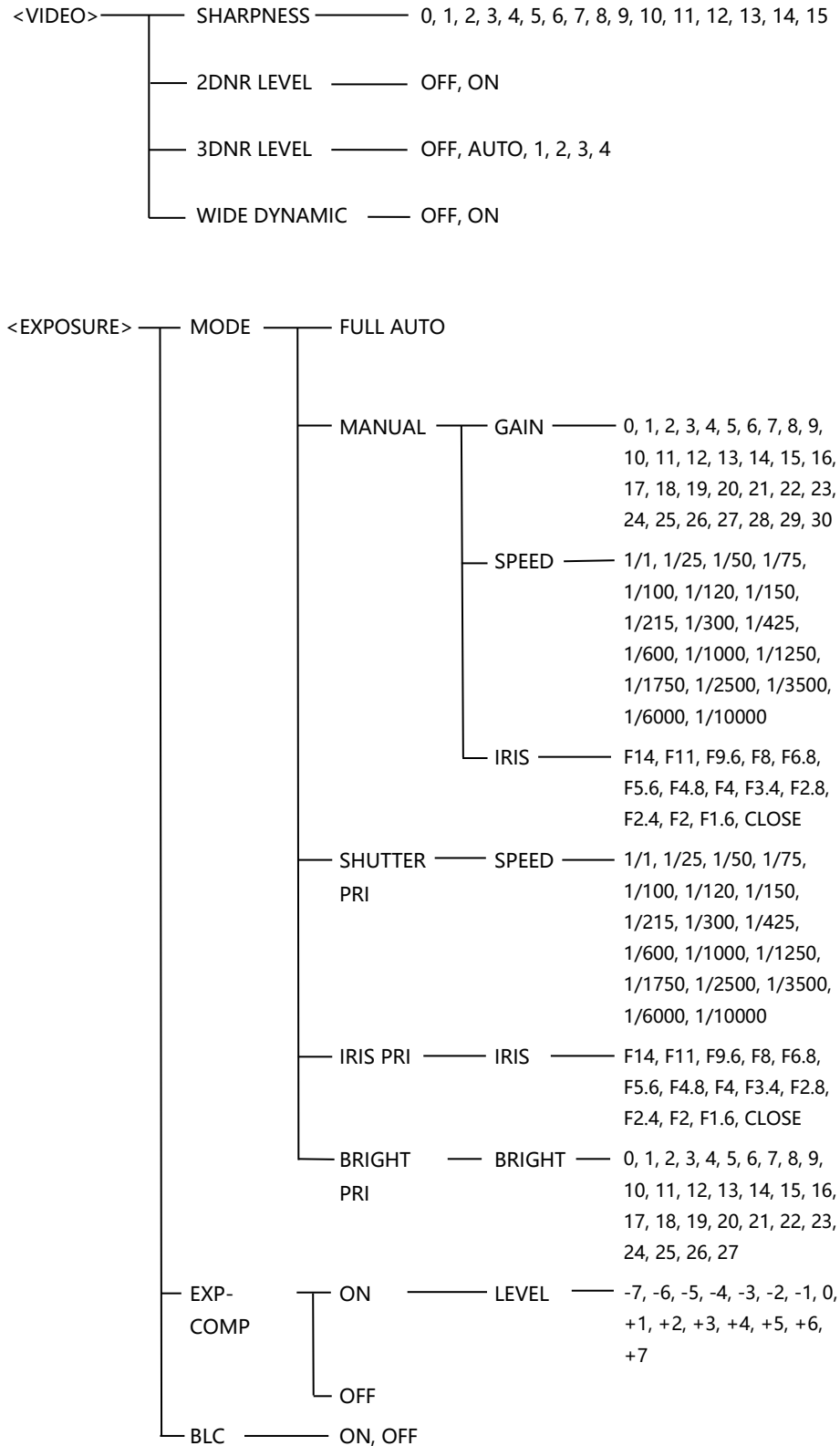

On Screen Display *(Continued)*

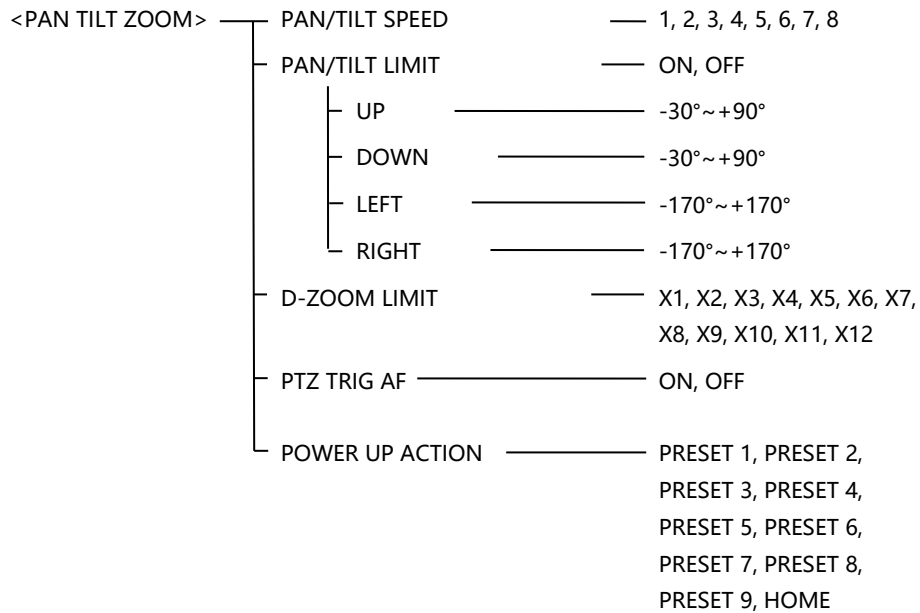
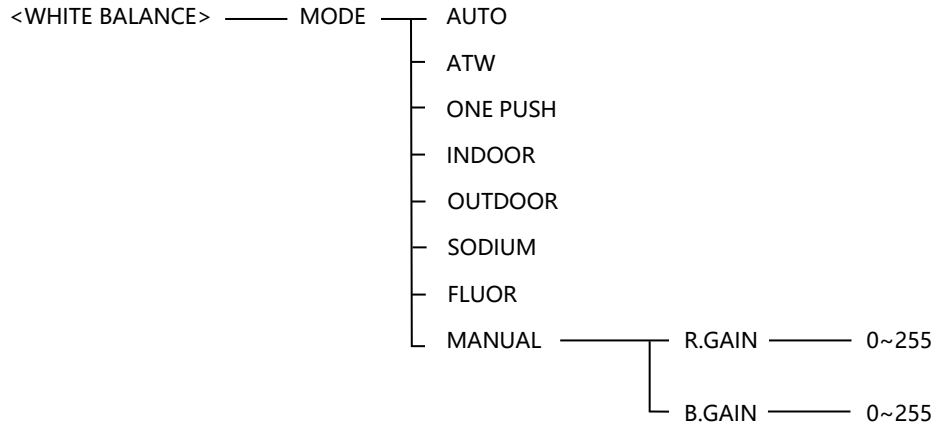



152 Robbins Rd, Downingtown, PA, 19335, USA - HuddleCamHD.com | 1 800 - 486-5276

On Screen Display *(Continued)*

<SYSTEM> ———— DISPLAY INFO _____ ON, OFF
 | RATIO SPEED _____ ON, OFF
 | PRESET FREEZE _____ ON, OFF
 | MOUNT _____ STAND, CEILING

<STATUS> ———— ADDRESS 1
 | PROTOCOL VISCA
 | BAUDRATE 9600
 | FORMAT 1080P50
 | MOUNT STAND
 | FIRMWARE VER V1.1.1

<RESTORE DEFAULTS>

VISCA Commands

ACK/Completion Messages

	Command Messages	Comments
ACK	z0 4y FF (y:Socket No.)	Returned when the command is accepted.
Completion	z0 5y FF (y:Socket No.)	Returned when the command has been executed.

Error Messages

	Command Messages	Comments
Syntax Error	z0 60 02 FF	Returned when the command format is different or when a command with illegal command parameters is accepted.
Command Buffer Full	z0 60 03 FF	Indicates that two sockets are already being used (executing two commands) and the command could not be accepted when received.
Command Canceled	z0 6y 04 FF (y:Socket No.)	Returned when a command which is being executed in a socket specified by the cancel command is canceled. The completion message for the command is not returned.
No Socket	z0 6y 05 FF (y:Socket No.)	Returned when no command is executed in a socket specified by the cancel command, or when an invalid socket number is specified.
Command Not Executable	z0 6y 41 FF (y:Execution command Socket No. Inquiry command:0)	Returned when a command cannot be executed due to current conditions. For example, when commands controlling the focus manually are received during auto focus.

z = Device address + 8



152 Robbins Rd, Downingtown, PA, 19335, USA - HuddleCamHD.com | 1 800 - 486-5276

Commands

Command Set	Command	Command Packet	Comments
AddressSet	Broadcast	88 30 01 FF	Address setting
IF_Clear	Broadcast	88 01 00 01 FF	I/F Clear
CommandCancel		8x 2p FF	p: Socket No.(=1or2)
CAM_Power	On	8x 01 04 00 02 FF	Power ON/OFF
	Off	8x 01 04 00 03 FF	
CAM_Zoom	Stop	8x 01 04 07 00 FF	p=0 (Low) to 7 (High) pqrs: Zoom Position
	Tele(Standard)	8x 01 04 07 02 FF	
	Wide(Standard)	8x 01 04 07 03 FF	
	Tele(Variable)	8x 01 04 07 2p FF	
	Wide(Variable)	8x 01 04 07 3p FF	
	Direct	8x 01 04 47 0p 0q 0r 0s FF	
CAM_Focus	Stop	8x 01 04 08 00 FF	p=0 (Low) to 7 (High) pqrs: Focus Position AF ON/OFF
	Far(Standard)	8x 01 04 08 02 FF	
	Near(Standard)	8x 01 04 08 03 FF	
	Far(Variable)	8x 01 04 08 2p FF	
	Near(Variable)	8x 01 04 08 3p FF	
	Direct	8x 01 04 48 0p 0q 0r 0s FF	
	Auto Focus	8x 01 04 38 02 FF	
	Manual Focus	8x 01 04 38 03 FF	
	Auto/Manual	8x 01 04 38 10 FF	
One Push Trigger	8x 01 04 18 01 FF	One Push AF Trigger	
CAM_ZoomFocus	Direct	8x 01 04 47 0p 0q 0r 0s	pqrs: Zoom Position
		0t 0u 0v 0w FF	tuvw: Focus Position
CAM_WB	Auto	8x 01 04 35 00 FF	Normal Auto
	Indoor	8x 01 04 35 01 FF	Indoor mode
	Outdoor	8x 01 04 35 02 FF	Outdoor mode
	One Push WB	8x 01 04 35 03 FF	One Push WB mode
	Manual	8x 01 04 35 05 FF	Manual Control mode
	One push trigger	8x 01 04 10 05 FF	One Push WB Trigger
CAM_RGain	Reset	8x 01 04 03 00 FF	Manual Control of R Gain pq: R Gain
	Up	8x 01 04 03 02 FF	
	Down	8x 01 04 03 03 FF	
	Direct	8x 01 04 43 00 00 0p 0q FF	
CAM_BGain	Reset	8x 01 04 04 00 FF	Manual Control of B Gain pq: B Gain
	Up	8x 01 04 04 02 FF	
	Down	8x 01 04 04 03 FF	
	Direct	8x 01 04 44 00 00 0p 0q FF	



152 Robbins Rd, Downingtown, PA, 19335, USA - HuddleCamHD.com | 1 800 - 486-5276

Commands (Continued)

Command Set	Command	Command Packet	Comments
CAM_AE	Full Auto	8x 01 04 39 00 FF	Automatic Exposure mode
	Manual	8x 01 04 39 03 FF	Manual Control mode
	Shutter Priority	8x 01 04 39 0A FF	Shutter Priority Automatic Exposure
	Iris Priority	8x 01 04 39 0B FF	Iris Priority Automatic Exposure mode
	Bright	8x 01 04 39 0D FF	Bright Mode (Manual control)
CAM_Shutter	Reset	8x 01 04 0A 00 FF	Shutter Setting
	Up	8x 01 04 0A 02 FF	
	Down	8x 01 04 0A 03 FF	
	Direct	8x 01 04 4A 00 00 0p 0q FF	pq: Shutter Position
CAM_Iris	Reset	8x 01 04 0B 00 FF	Iris Setting
	Up	8x 01 04 0B 02 FF	
	Down	8x 01 04 0B 03 FF	
	Direct	8x 01 04 4B 00 00 0p 0q FF	pq: Iris Position
CAM_Gain	Reset	8x 01 04 0C 00 FF	Gain Setting
	Up	8x 01 04 0C 02 FF	
	Down	8x 01 04 0C 03 FF	
	Direct	8x 01 04 4C 00 00 0p 0q FF	pq: Gain Position
CAM_Bright	Reset	8x 01 04 0D 00 FF	Bright Setting
	Up	8x 01 04 0D 02 FF	
	Down	8x 01 04 0D 03 FF	
	Direct	8x 01 04 4D 00 00 0p 0q FF	pq: Bright Position
CAM_ExpComp	On	8x 01 04 3E 02 FF	Exposure Compensation ON/OFF
	Off	8x 01 04 3E 03 FF	
	Reset	8x 01 04 0E 00 FF	Exposure Compensation Amount Setting
	Up	8x 01 04 0E 02 FF	
	Down	8x 01 04 0E 03 FF	
	Direct	8x 01 04 4E 00 00 0p 0q FF	pq: ExpComp Position
CAM_Backlight	On	8x 01 04 33 02 FF	Back Light Compensation ON/OFF
	Off	8x 01 04 33 03 FF	
CAM_Aperture	Reset	8x 01 04 02 00 FF	Aperture Control
	Up	8x 01 04 02 02 FF	
	Down	8x 01 04 02 03 FF	
	Direct	8x 01 04 42 00 00 0p 0q FF	pq: Aperture Gain
CAM_PictureEffect	Off	8x 01 04 63 00 FF	Picture Effect Setting
	Neg.Art	8x 01 04 63 02 FF	
	B&W	8x 01 04 63 04 FF	
CAM_Memory	Reset	8x 01 04 3F 00 pp FF	pp: Memory Number (=0 to 255)
	Set	8x 01 04 3F 01 pp FF	Corresponds to 0 to 255 on the Remote Commander.
	Recall	8x 01 04 3F 02 pp FF	
SYS_Menu	Off	8x 01 06 06 03 FF	Turns off the menu screen.



152 Robbins Rd, Downingtown, PA, 19335, USA - HuddleCamHD.com | 1 800 - 486-5276

Commands *(Continued)*

Command Set	Command	Command Packet	Comments
CAM_IDWrite		8x 01 04 22 0p 0q 0r 0s FF	pqrs: Camera ID (=0000 to FFFF)
IR_Receive	On	8x 01 06 08 02 FF	IR(remote commander) receive ON/OFF
	Off	8x 01 06 08 03 FF	
Information Display	On	8x 01 7E 01 18 02 FF	ON/OFF of the Operation status display
	Off	8x 01 7E 01 18 03 FF	
Pan-tiltDrive	Up	8x 01 06 01 VV WW 03 01 FF	VV: Pan speed 0 x01 (low speed) to 0 x18 (high speed) WW: Tilt Speed 0 x 01 (low speed) to 0 x14 (high speed) YYYY: Pan Position ZZZZ: Tilt Position
	Down	8x 01 06 01 VV WW 03 02 FF	
	Left	8x 01 06 01 VV WW 01 03 FF	
	Right	8x 01 06 01 VV WW 02 03 FF	
	UpLeft	8x 01 06 01 VV WW 01 01 FF	
	UpRight	8x 01 06 01 VV WW 02 01 FF	
	DownLeft	8x 01 06 01 VV WW 01 02 FF	
	DownRight	8x 01 06 01 VV WW 02 02 FF	
	Stop	8x 01 06 01 VV WW 03 03 FF	
	AbsolutePosition	8x 01 06 02 VV WW 0Y 0Y 0Y 0Y 0Z 0Z 0Z 0Z FF	
	RelativePosition	8x 01 06 03 VV WW 0Y 0Y 0Y 0Y 0Z 0Z 0Z 0Z FF	
	Home	8x 01 06 04 FF	
Reset	8x 01 06 05 FF		
Pan-tiltLimitSet	LimitSet	8x 01 06 07 00 0W 0Y 0Y 0Y 0Y 0Z 0Z 0Z 0Z FF	W: 1 UpRight 0: DownLeft YYYY: Pan Limit Position ZZZZ: Tilt Position



152 Robbins Rd, Downingtown, PA, 19335, USA - HuddleCamHD.com | 1 800 - 486-5276

Inquiry Commands

Inquiry Command	Command Packet	Inquiry Packet	Comments
CAM_PowerInq	8x 09 04 00 FF	y0 50 02 FF	On
		y0 50 03 FF	Off (Standby)
		y0 50 04 FF	Internal power circuit error
CAM_ZoomPosInq	8x 09 04 47 FF	y0 50 0p 0q 0r 0s FF	pqrs: Zoom Position
CAM_FocusModeInq	8x 09 04 38 FF	y0 50 02 FF	Auto Focus
		y0 50 03 FF	Manual Focus
CAM_FocusPosInq	8x 09 04 48 FF	y0 50 0p 0q 0r 0s FF	pqrs: Focus Position
CAM_WBModeInq	8x 09 04 35 FF	y0 50 00 FF	Auto
		y0 50 01 FF	In Door
		y0 50 02 FF	Out Door
		y0 50 03 FF	One Push WB
		y0 50 05 FF	Manual
CAM_RGainInq	8x 09 04 43 FF	y0 50 00 00 0p 0q FF	pq: R Gain
CAM_BGainInq	8x 09 04 44 FF	y0 50 00 00 0p 0q FF	pq: B Gain
CAM_AEModeInq	8x 09 04 39 FF	y0 50 00 FF	Full Auto
		y0 50 03 FF	Manual
		y0 50 0A FF	Shutter Priority
		y0 50 0B FF	Iris Priority
		y0 50 0D FF	Bright
CAM_ShutterPosInq	8x 09 04 4A FF	y0 50 00 00 0p 0q FF	pq: Shutter Position
CAM_IrisPosInq	8x 09 04 4B FF	y0 50 00 00 0p 0q FF	pq: Iris Position
CAM_GainPosInq	8x 09 04 4C FF	y0 50 00 00 0p 0q FF	pq: Gain Position
CAM_BrightPosInq	8x 09 04 4D FF	y0 50 00 00 0p 0q FF	pq: Bright Position
CAM_ExpCompModeInq	8x 09 04 3E FF	y0 50 02 FF	On
		y0 50 03 FF	Off
CAM_ExpCompPosInq	8x 09 04 4E FF	y0 50 00 00 0p 0q FF	pq: ExpComp Position
CAM_BacklightModeInq	8x 09 04 33 FF	y0 50 02 FF	On
		y0 50 03 FF	Off
CAM_ApertureInq	8x 09 04 42 FF	y0 50 00 00 0p 0q FF	pq: Aperture Gain
CAM_PictureEffectModeInq	8x 09 04 63 FF	y0 50 00 FF	Off
		y0 50 02 FF	Neg.Art
		y0 50 04 FF	B&W
CAM_MemoryInq	8x 09 04 3F FF	y0 50 0p FF	p: Memory number last operated.
SYS_MenuModeInq	8x 09 06 06 FF	y0 50 02 FF	On
		y0 50 03 FF	Off
CAM_IDInq	8x 09 04 22 FF	y0 50 0p 0q 0r 0s FF	pqrs: Camera ID



152 Robbins Rd, Downingtown, PA, 19335, USA - HuddleCamHD.com | 1 800 - 486-5276

Inquiry Commands (Continued)

Inquiry Command	Command Packet	Inquiry Packet	Comments
CAM_VersionInq	8x 09 00 02 FF	y0 50 00 01 mn pq rs tu vw FF	mnpq: Model Code (0504) rstu: ROM version vw: Socket Number (=02)
Information Display	8x 09 7E 01 18 FF	y0 50 02 FF	On
		y0 50 03 FF	Off
VideoSystemInq	8x 09 06 23 FF	y0 50 00 FF	1920 x1080i/60
		y0 50 01 FF	1920 x1080p/30
		y0 50 02 FF	1280 x720p/60
		y0 50 03 FF	1280 x720p/30
		y0 50 07 FF	1920 x1080p/60
		y0 50 08 FF	1920 x1080i/50
		y0 50 09 FF	1920 x1080p/25
		y0 50 0A FF	1280 x720p/50
		y0 50 0B FF	1280 x 720p/25
		y0 50 0F FF	1920 x1080p/50
IR_Receive	8x 09 06 08 FF	y0 50 02 FF	On
		y0 50 03 FF	Off
Pan-tiltMaxSpeedInq	8x 09 06 11 FF	y0 50 ww zz FF	ww = Pan Max Speed zz = Tilt Max Speed
Pan-tiltPosInq	8x 09 06 12 FF	y0 50 0w 0w 0w 0w 0z 0z 0z 0z FF	wwww = Pan Position zzzz = Tilt Position
Pan-tiltModelInq	8x 09 06 10 FF	y0 50 pq rs FF	pqrs: Pan/Tilt Status



152 Robbins Rd, Downingtown, PA, 19335, USA - HuddleCamHD.com | 1 800 - 486-5276

Tips and Tricks

The “Stage”: Imagine your subject moving around within the available presentation space and take note of the extremes, left or right and up or down, your presenter may happen to present from. The area you have just noted is what we will call our stage and is what you want to ensure is captured by the reference camera. Within this stage we normally want to set the priority tracking area to slightly above the presenter’s head for the top boundary and just above the audience’s heads for the bottom boundary.

Shot Composition: For a nice tight shot around the subject, the camera must be within 55’ of the subject. Beyond that, composition will be sacrificed for distance.

Motion: The faster the subject moves, the larger the shot composition should be. Depending on the subject, and desired impact, this is something that can require a bit of trial and error to find that perfect composition to high motion ratio.

Keep it Simple: When diving into the Advanced Parameters section of the software, think about what you’re trying to capture. Only enable the features you need to properly track within your “stage.” As an example, if you have a presenter at the front of the room only moving left or right do not enable Auto-Zoom or Auto-Tilt, as you’re just inviting undesired tracking results.

Plan Ahead: Before any event, large or small, test your entire setup as far in as possible. Waiting until the last minute is never a good idea.



152 Robbins Rd, Downingtown, PA, 19335, USA - HuddleCamHD.com | 1 800 - 486-5276

Care of the Unit

Remove dust or dirt on the surface of the lens with a blower (*commercially available*).

Troubleshooting

Problem	Possible Cause	Solution
No movement or image after power on	Power supply failure	Check power supply
	Power adapter damaged	Replace power adapter
	Power cable connection is loose	Check & reconnect
No self-testing after powered on, or with motor noise	Not enough power	Check & reconnect power cable connection
	Mechanical failure	Send for authorized repair
After power on, self-test successfully, but not controllable	Wrong address / protocol / baud rate	Check & set again
	Wrong connection or open circuit of RS-485/RS422 or RS-232 cable	Check & reconnect
Video loss when pans / tilts / zooms	Not enough power	Check & reconnect power cable
	Video cable not properly connected	Replace with a tested cable
Auto tracking has locked on the wrong subject / object with no motion	Lack of adequate lighting on the subject	Increase proper lighting on subject / stage. If the problem persists attempt to move the camera closer to the stage.
	Too complex of a scene with slightly improper lighting	
The tracking camera seems to be off from the reference camera settings	The camera has been moved	Manually move camera back into place or rebuild tracking zones
	A manual tracking / reference camera recalibration is required	Enter the Advanced Parameters settings and click the Pos Correct button. Once the tracking camera stops moving, align the crosshairs of the tracking camera to match the crosshairs of the reference camera.
The camera is tracking slightly below or above the subject	A manual height recalibration is required	Enter the Advanced Parameters settings and click the Debug button. Have your subject stand in place within facing the tracking camera. Once a rectangle is around the face, use the Up and Down buttons to adjust tracking height.
Having trouble finding / connecting to camera on the network	No DHCP Server available	Connect to camera and set a static IP in the Configuration interface
	Multiple Network Connections	Disable any secondary and or tertiary network connections on your Windows PC



152 Robbins Rd, Downingtown, PA, 19335, USA - HuddleCamHD.com | 1 800 - 486-5276

Notes
